

Safe use of ladders and stepladders

An employers' guide



Introduction

1 A third of all reported fall-from-height incidents involve ladders and stepladders, on average this accounts for **14 deaths** and **1200 major injuries** to workers each year. Many of these injuries are caused by inappropriate or incorrect use of the equipment. This guidance is to help employers:

- know when to use a ladder;
- decide how to go about selecting the right sort of ladder for the particular job;
- understand how to use it;
- know how to look after it; and
- take sensible safety precautions.

2 HSE believes that misuse of ladders at work can be partly explained by the way they are used in the home. Like all work equipment, users need adequate information and training to be able to use ladders and stepladders safely. Adequate supervision is needed so that safe practices continue to be used.

3 This guidance does not apply to fixed ladders (on buildings, plant or vehicles), other types of fixed access (step irons etc), specialist rescue ladders used by the fire service, roof ladders, step stools, warehouse steps/mobile stairs, or temporary or permanent stairs.



When is a ladder the most suitable access equipment?



Figure 1a *Incorrect - Overreaching and not maintaining three points of contact*

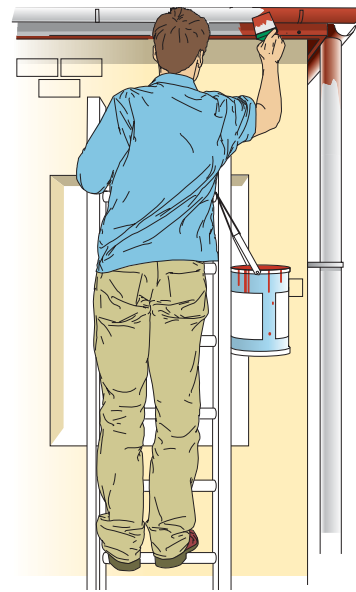

Figure 1b *Correct - user maintaining three points of contact*

4 This selection process has to take into account the hierarchy of controls:¹

- firstly to avoid work at height where possible;
- then to prevent falls from height; and, failing that,
- to reduce the consequences of a fall.

5 Where work at height is necessary you need to justify whether a ladder or stepladder is the most suitable access equipment compared to other access equipment options. You do this by using risk assessment and the hierarchy of controls.

6 When considering whether it could be appropriate to use a ladder or stepladder, you need to consider the following factors.

Is it a suitable activity?

7 This refers to the type of work and its duration. As a guide, **only** use a ladder or stepladder:

- in one position for a maximum of 30 minutes;
- for 'light work' - they are not suitable for strenuous or heavy work. If a task involves a worker carrying more than 10 kg (a bucket of something) up the ladder or steps it

will need to be justified by a detailed manual handling assessment;

- where a handhold is available on the ladder or stepladder;
 - where you can maintain three points of contact (hands and feet) at the working position. On a **ladder** where you cannot maintain a handhold, other than for a brief period of time, other measures will be needed to prevent a fall or reduce the consequences of one. On **stepladders** where a handhold is not practicable a risk assessment will have to justify whether it is safe or not (see paragraph 10 for details).
- 8 On a ladder or stepladder **do not**:
- overload it - the person and anything they are taking up should not exceed the highest load stated on the ladder;
 - overreach - keep your belt buckle (navel) inside the stiles and both feet on the same rung throughout the task (see Figures 1a and 1b).
- 9 When working on **stepladders** you should avoid work that imposes a side loading, such as side-on drilling through solid materials (eg bricks or concrete), by having the steps facing the work activity (see Figures 2a and 2b). Where side-on loadings cannot be avoided you should prevent the steps from tipping over, for example by tying the steps to a suitable point. Otherwise a more suitable type of access equipment should be used.

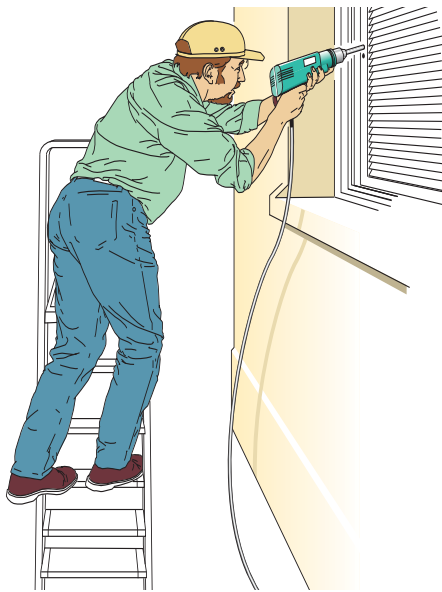

Figure 2a *Incorrect - steps side-on to work activity*

10 You should also avoid holding items when climbing (for example by using tool belts):

- on a **ladder** where you must carry something you must have one free hand to grip the ladder;
- on a **stepladder** where you cannot maintain a handhold (eg putting a box on a shelf), the use of a stepladder will have to be justified by taking into account:
 - the height of the task;
 - a safe handhold still being available on the stepladder;
 - whether it is light work (see paragraph 7);
 - whether it avoids side loading (see paragraph 9);
 - whether it avoids overreaching (see paragraph 8);
 - whether the user's feet are fully supported; and
 - whether you can tie the stepladder (see paragraph 16).



Figure 2b *Correct - steps facing work activity*

Selecting/buying safe ladders and stability devices

11 When buying a new ladder, think about the worst type of surface conditions you come across (eg smooth, wet floor tiles). Manufacturers should be able to indicate the types of surfaces their products are intended to be used on when they are unsecured (untied). Only buy the ladder and associated stability devices that suppliers/manufacturers can confirm will be stable enough to be used unsecured in your worst-case scenario, otherwise you will need to take additional measures to secure it (see paragraphs 14-16).

12 HSE and DTI recommend Class 1^{2,3} 'Industrial' or EN131⁴ ladders or stepladders for use at work. Make sure the ladder is a suitable size for the work (see paragraphs 9 and 22).

Is it a safe place to use a ladder or stepladder?

13 This is the specific place where you are going to set up and use it. As a guide, **only** use ladders or stepladders:

- on firm ground or spread the load (eg use a board);
- on level ground - for **stepladders** refer to the manufacturer's instructions, for **ladders** the maximum safe ground slopes on a suitable surface (unless the manufacturer states otherwise) are as follows:
 - side slope 16° – but the rungs still need to be levelled (see Figure 3);
 - back slope 6° (see Figure 3);

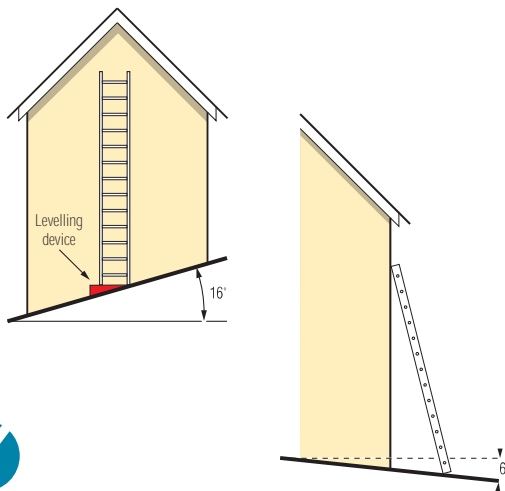

Figure 3 Ladder showing maximum angles at 16° on a side slope and 6° on a back slope

- on clean, solid surfaces (paving slabs, floors etc). These need to be clean (no oil, moss or leaf litter) and free of loose material (sand, packaging materials etc) so the feet can grip. Shiny floor surfaces can be slippery even without contamination;
- where it has been secured.

14 The options for securing a **ladder** are as follows:

- tie the ladder to a suitable point, making sure both stiles are tied, see Figures 4, 5, 6 and 7;
- where this is not practical, use a safe, unsecured ladder or a ladder supplemented with an effective ladder stability device (see paragraph 11);
- if this is not possible, then securely wedge the ladder, eg against a wall;
- if none of the above can be achieved, foot the ladder. Footing is the last resort and should be avoided, where reasonably practicable, by the use of other access equipment.

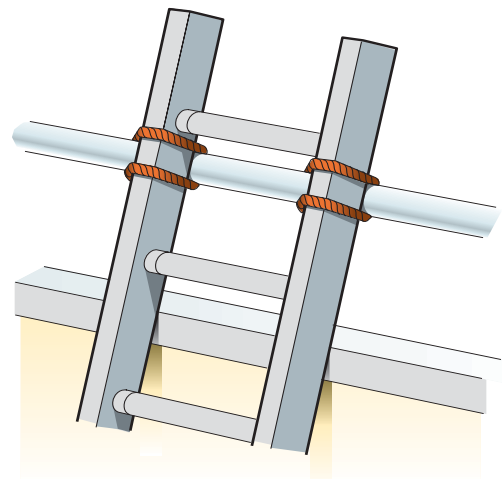

Figure 4 Ladder tied at top stiles (correct for working on, not for access)



Figure 5 Tying part way down

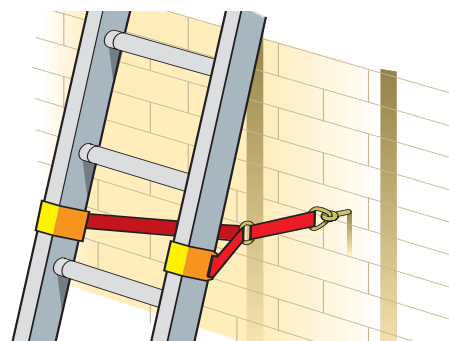

Figure 6 Tying near the base

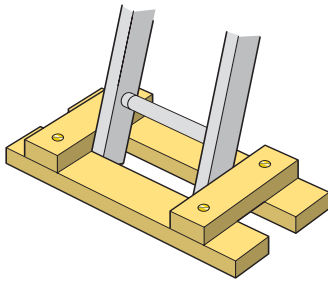

Figure 7 Tying at the base

15 **Ladders** used for access to another level should be tied (see Figure 8). **Stepladders** should not be used for access to another level unless they have been designed for this.

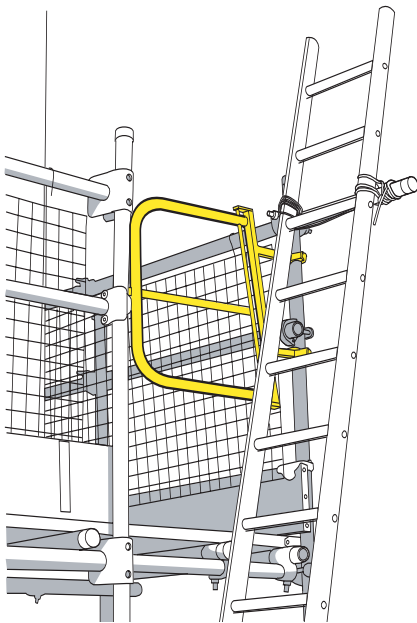

Figure 8 Access ladders should be tied and extend at least 1 m above the landing point to provide a secure handhold

16 Consider tying a **stepladder** where possible and advantageous to the task (eg side-on working or where two free hands are needed).

17 You should **only** use ladders or stepladders:

- where they will not be struck by vehicles, by protecting them with suitable barriers or cones;
- where they will not be pushed over by other hazards such as doors or windows, by securing doors (not fire exits) and windows where possible. If this is impractical, have a person standing guard at a doorway, or inform workers not to open windows until they are told to do so;
- where pedestrians are prevented from walking under them or near them, by using barriers, cones or, as a last resort, a person standing guard at the base;
- where **ladders** can be put up at the correct angle of 75°. To judge the angle use the angle indicator marked on the stiles of some ladders or the 1 in 4 rule (1 unit out for every 4 units up, as shown in Figure 10);
- where the restraint devices on **stepladders** can be fully opened. Any locking devices must also be engaged.

18 On a ladder or stepladder:

- don't work within 6 m horizontally of any overhead power lines, unless the line owner has made them dead or protected with temporary insulation. If this is a regular activity, find out if the lines can be moved;
- always use a non-conductive ladder or steps for any necessary⁵ live electrical work;
- don't rest **ladders** against weak upper surfaces (eg glazing or plastic gutters). Alternatively, you can use effective spreader bars or effective stand-offs (see Figure 9).

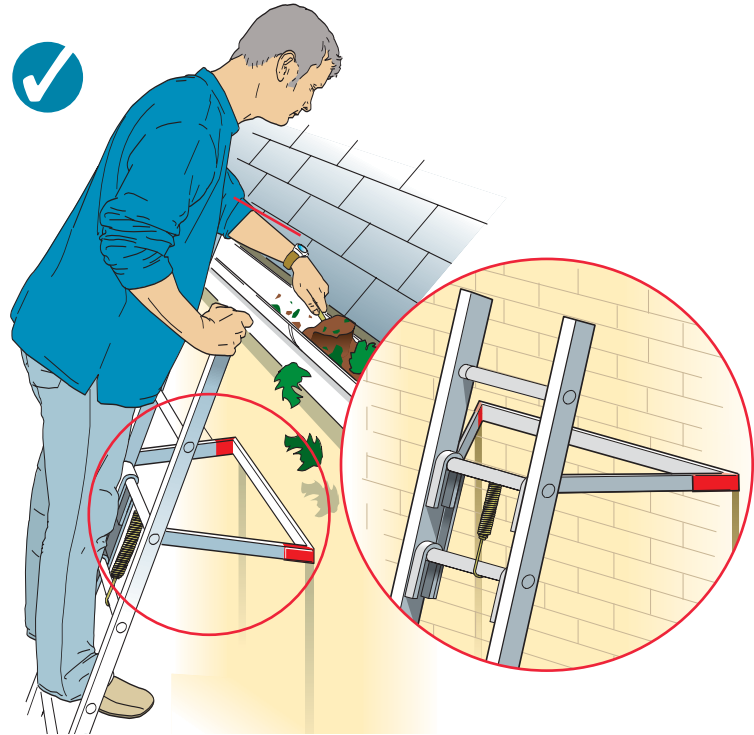

Figure 9 Stand-off device and working maximum height on a ladder

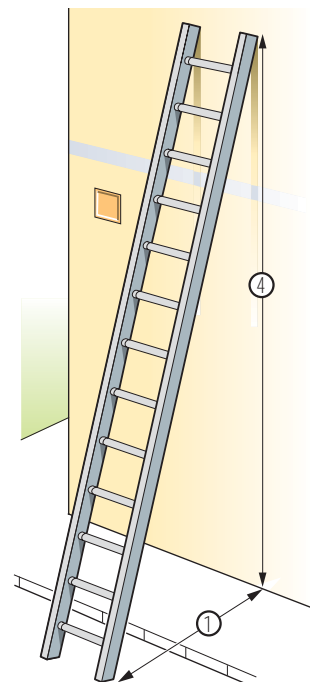

Figure 10 Ladder showing correct 1 in 4 angle (means of securing omitted for clarity)

Is the ladder or stepladder safe to be used?

19 Establish the ladder or stepladder is in a safe condition before using it. As a guide, **only** use ladders or stepladders that:

- have no visible defects. They should have a pre-use check each working day;
- have a current detailed visual inspection. These should be done in accordance with the manufacturer's instructions. Ladders that are part of a scaffold system still have to be inspected every seven days;
- are suitable for work use. Use Class 1^{2,3} or EN 131⁴ ladders or stepladders at work because domestic (Class 3^{2,3}) ones are not normally suitable for use at work;
- have been maintained and stored in accordance with the manufacturer's instructions.

What are pre-use checks and detailed visual inspections?

20 Both are looking for obvious visual defects, they only differ in detail. Both can be done in-house (pre-use checks should be part of a user's training). Detailed visual inspections should be recorded. Ladder stability devices and other accessories should be pre-use checked and inspected in accordance with the manufacturer's instructions. Ladder and stepladder feet must be part of the pre-use check. Ladder feet are essential for preventing the base of the ladder slipping. Missing stepladder feet cause it to wobble. The feet should be:

- in good repair (not loose, missing, splitting, excessively worn, secure etc); and
- clean – the feet should be in contact with the ground.

21 Ladder feet should also be checked when moving from soft/dirty ground (eg dug soil, loose sand/stone, a dirty workshop) to a smooth, solid surface (eg paving slabs), to ensure the foot material and not the dirt (eg soil, embedded stones or swarf) is making contact with the ground.



Do my ladder-users know how to use them safely?

22 These are common issues about setting up and using ladders under the direct control of the user. Users should also be aware of the limitations covered in the other headings. People should **only** use a ladder, stepladder or stability device if:

- they are competent - users should be trained and instructed to use the equipment safely;
- the ladder or stepladder is long enough -
 - for **ladders**:
 - don't use the top three rungs (see Figure 9);
 - ladders used for access should project at least 1 m above the landing point and be tied; alternatively a safe and secure handhold should be available (see Figure 8);
 - for **stepladders**:
 - don't use the top two steps of a stepladder, unless a suitable handrail is available on the stepladder (See Figure 11);
 - don't use the top three steps of swing-back or double-sided stepladders, where a step forms the very top of the stepladder (see Figure 12);
- the ladder or stepladder rungs or steps are level. This can be judged by the naked eye. **Ladders** can be levelled using specially designed devices but not by using bits of brick or whatever else is at hand;
- the weather is suitable - do not use them in strong or gusting winds (follow the manufacturer's safe working practices);
- they are wearing robust, sensible footwear (eg safety shoes/boots or trainers). Shoes should not have the soles hanging off, have long or dangling laces, or be thick with mud or other slippery contaminants;
- they know how to prevent members of the public and other workers from using them;
- they are fit - certain medical conditions or medication, alcohol or drug abuse could stop them from using ladders. If you are in any doubt, speak to an occupational health professional;
- they know how to tie a ladder or stepladder properly.

23 On a ladder or stepladder, **don't**:

- move them while standing on the rungs/steps;
- support them by the rungs or steps at the base;
- slide down the stiles;
- stand them on moveable objects, such as pallets, bricks, lift trucks, tower scaffolds, excavator buckets, vans, or mobile elevating work platforms;
- extend a ladder while standing on the rungs.

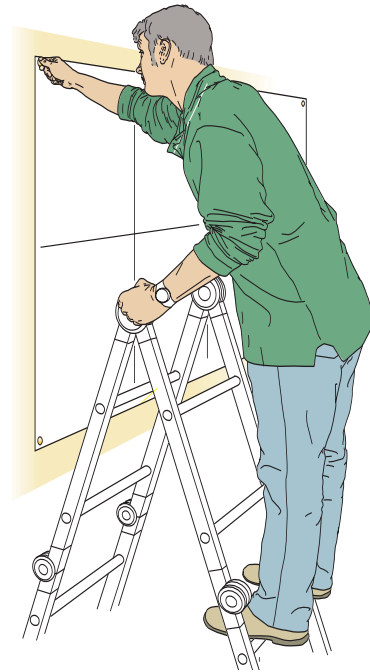

Figure 11 Correct - two clear rungs. Don't work any higher up this type of stepladder



Figure 12 Correct - three clear steps. Don't work any higher up this type of stepladder

References and further reading

References

- 1 *The Work at Height Regulations 2005: A brief guide*
Leaflet INDG401 HSE Books 2005 (single copy free or priced packs of 10 ISBN 0 7176 2976 7)
- 2 BS 1129: 1990 *British standard specification for portable timber ladders, steps, trestles and lightweight stagings* British Standards Institution
- 3 BS 2037: 1994 *Specification for portable aluminium ladders, steps, trestles and lightweight stagings* British Standards Institution
- 4 BS EN 131-1 *Ladders. Part 1: Specification for terms, types, functional sizes* (1993) and BS EN 131-2 *Ladders. Part 2: Specification for requirements, testing, marking* (1993) British Standards Institution
- 5 *Memorandum of guidance on the Electricity at Work Regulations 1989. Guidance on Regulations HSR25*
HSE Books 1989 ISBN 07176 1602 9

Further reading

- A toolbox talk on leaning ladder and stepladder safety*
Leaflet INDG403 HSE Books 2005 (single copy free or priced packs of 5 ISBN 07176 6106 7)
- Top tips for ladder safety* Pocket card INDG405
HSE Books 2005 (single copy free or priced packs of 25 ISBN 0 7176 6127 X)
Online at: www.hse.gov.uk/pubns/indg405.pdf
- Evaluating the performance and effectiveness of ladder stability devices* RR205 HSE Books 2004 ISBN 07176 2872 1
- Ergonomics evaluation into the safety of stepladders. Literature and standards review Phase 1* CRR418
HSE Books 2002 ISBN 07176 2302 5
- Ergonomics evaluation into the safety of stepladders. User profile and dynamic testing - Phase 2* CRR423 HSE Books 2002 ISBN 0 7176 2315 1
- Falls from height webpages on the HSE website:
www.hse.gov.uk/falls/index.htm

Further information



HSE priced and free publications are available by mail order from HSE Books, PO Box 1999, Sudbury, Suffolk CO10 2WA Tel: 01787 881165 Fax: 01787 313995 Website: www.hsebooks.co.uk (HSE priced publications are also available from bookshops and free leaflets can be downloaded from HSE's website: www.hse.gov.uk.)

For information about health and safety ring HSE's Infoline Tel: 0845 345 0055 Fax: 0845 408 9566 Textphone: 0845 408 9577 e-mail: hseinformationservices@natbrit.com or write to HSE Information Services, Caerphilly Business Park, Caerphilly CF83 3GG.

This leaflet contains notes on good practice which are not compulsory but which you may find helpful in considering what you need to do.

This leaflet is available in priced packs of 5 from HSE Books, ISBN 0 7176 6105 9. Single free copies are also available from HSE Books. It can also be viewed online at: www.hse.gov.uk/pubns/indg402.pdf

© *Crown copyright* This publication may be freely reproduced, except for advertising, endorsement or commercial purposes. First published 09/05. Please acknowledge the source as HSE.